

SOLAIO

design: Carlo Cumini, 1993



Libreria con spalle in legno massello di faggio naturale tinto, spessore mm 15. Ripiani in MDF laccato, spessore mm 28, fresati sul lato inferiore per consentire il montaggio ad incastro tra ripiani e montanti. Schiene in pannello di particelle di legno, nobilitato e laccato. Piedini regolabili.

Bookcase with sides made from solid natural stained beech, 15 mm thick. Shelves made from lacquered MDF, 28 mm thick, milled on the lower side for modular mounting of the shelves and uprights. Back sections made from particleboard, melamine-coated and lacquered. Adjustable feet.

Bibliothèque à parois en hêtre massif naturel ou teinté, d'une épaisseur de 15 mm. Étagères en fibre de densité moyenne laquées, d'une épaisseur de 28 mm, fraisées sur le côté inférieur pour permettre un montage à encastrement entre les étagères et les montants. Panneaux de fond en panneaux de particules de bois mélaminés et laqués. Vérins.

Bücherregal mit Seiten aus gefärbter massiver Naturbuche, Stärke 15 mm. Einlegeböden aus lackierten MDF-Platten, Stärke 28 mm, gefräst an der unteren Seite, um die Einrastmontage zwischen Einlegeböden und Pfosten zu ermöglichen. Rückenwände aus veredelten und lackierten Spanplatten. Verstellbare Füße.

Librería con armazón de madera maciza de haya natural teñida, espesor 15 mm. Estantes de MDF lacado, espesor 28 mm, fresados en el lado inferior para permitir el montaje con ensambladura entre estantes y montantes. Respaldos de panel de partículas de madera, ennoblecido y lacado. Pies ajustables.

Solaio è un sistema versatile dalle numerose possibilità di composizione.

Solaio is a versatile system that can be put together in different ways.

Solaio est un système universel aux nombreuses possibilités de composition.

Solaio ist ein vielseitiges System mit zahlreichen Kombierungsmöglichkeiten.

Solaio es un sistema versátil con numerosas posibilidades de composición.

I ripiani sono fresati sul fondo in corrispondenza dei montanti. In tal modo, possono essere **fissati ad incastro** sui montanti senza l'ausilio di supporti metallici (vedi disegno 1). La lunghezza dei ripiani è pari allo sviluppo lineare della composizione, **senza giunture**, fino a una lunghezza massima del ripiano di cm 300.

The shelves are milled underneath at the point where they meet the struts. This means the shelves **can be fitted** on the struts without the need for metal supports. The shelves of a multi-modular bookcase are the same length as the bookcase itself, **without joins**, and measure a maximum of 300 cm.

Les étagères sont fraisées comme les montants. Elles peuvent ainsi **être encastrées** sur les montants sans que des supports métalliques soient nécessaires. Dans les compositions comprenant plusieurs modules, la longueur des étagères correspond à la longueur de la composition, **sans ajouts**, jusqu'à une longueur maximale de l'étagère de 300 cm.

Die Einlegeböden sind am Boden, auf der Höhe der Pfosten gefräst. Auf diese Weise können sie mittels der **Steckverbindung direkt** an denselben ohne Verwendung von Metallhalterungen befestigt werden. Bei der Komposition mehrerer Module entspricht die Länge der Einlegeböden der linearen Ausbreitung dieser Komposition, **ohne Verbindungsstellen**, bis zu einer maximalen Länge der Einlegeböden von 300 cm.

Los estantes están fresados en el fondo, para que concuerden con los montantes. Así, se pueden **fijar ensamblándose** sobre ellos, sin necesidad de soportes metálicos. En las composiciones de más módulos, la longitud de los estantes es igual a la longitud lineal de la composición **sin juntas**, hasta una longitud máxima del estante de 300 cm.

Al fine di dare **stabilità strutturale** alla composizione desiderata, è necessario inserire sempre una o più schiene (vedi disegno 2) a seconda della larghezza della libreria. Consigliamo ai rivenditori di inviare sempre al Customer Service HORM un disegno della composizione che desiderano ordinare, al fine di valutarne la stabilità strutturale. Infine, per una **sicurezza totale** è necessario ancorare la libreria a parete con le apposite squadrette in dotazione.

One or more backs need to be fitted, depending on the width of the required version, to guarantee the **structural stability** of the bookcase. Retailers are always advised to send a drawing to the HORM Customer Service showing the version they require, for assessing its structural stability. To guarantee **absolute safety**, it is also necessary to fix the bookcase on the wall using the brackets provided.

Afin de donner une **stabilité structurelle** à la composition désirée, vous devez toujours insérer un ou plusieurs fonds selon la largeur de la bibliothèque. Nous conseillons aux revendeurs de toujours envoyer au Service clientèle HORM un dessin de la composition qu'ils souhaitent commander, afin d'évaluer la stabilité de la structure. Enfin, pour une **sécurité totale**, il est nécessaire de fixer la bibliothèque au mur avec les crochets spéciaux qui sont fournis.

Um der gewünschten **Komposition Stabilität** zu verleihen, muss je nach Breite des Bücherregals eine oder mehrere Rückwände eingebaut werden. Wir empfehlen dem Verkäufer, dem Kundendienst der Firma HORM stets eine Zeichnung der zu bestellenden Komposition zuzuschicken, um die Stabilität der Struktur abzuwägen. Aus **Sicherheitsgründen** muss das Bücherregal mittels der mitgelieferten Winkelhalter an der Wand befestigt werden.

Con el fin de proporcionar **estabilidad estructural** a la composición deseada, se han de introducir siempre uno o más respaldos, según la anchura de la librería. Recomendamos a los distribuidores que envíen siempre al Departamento de Atención al Cliente de HORM un diseño de la composición que deseen pedir, con el fin de valorar su estabilidad estructural. Finalmente, para una **seguridad total**, se ha de anclar la librería a la pared, con los correspondientes soportes incluidos.

I piedini sono regolabili.

The feet are adjustable.

Les pieds sont réglables.

Die Füße sind regulierbar.

Los pies son ajustables.

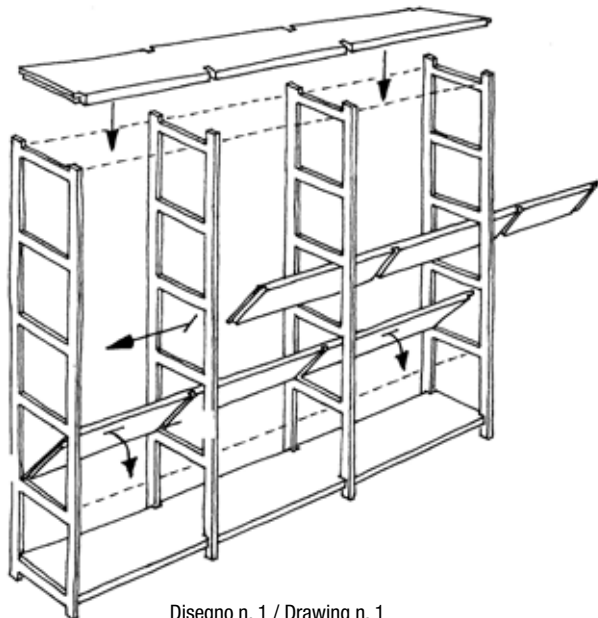

Disegno n. 1 / Drawing n. 1

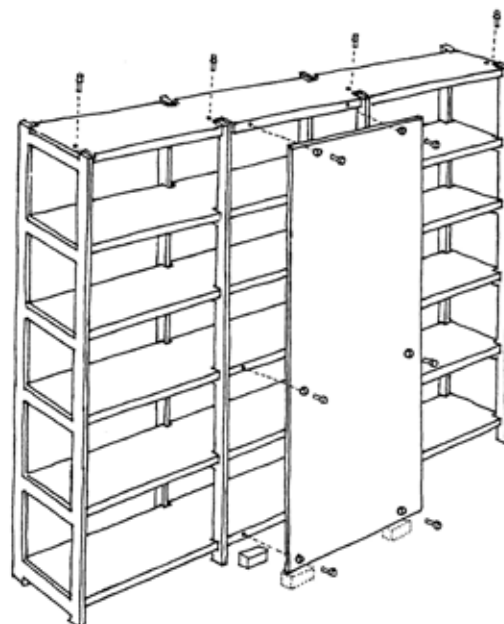

Disegno n. 2 / Drawing n. 2

ESEMPIO

Come comporre una libreria con gli elementi elencati nella pagine successive

EXAMPLE

How to mount a bookcase with the components listed further on

EXEMPLE

Comment composer une bibliothèque avec les éléments répertoriés dans les pages suivantes

BEISPIEL

Zusammensetzung eines Bücherregals mit den auf den folgenden Seiten aufgelisteten Elementen

EJEMPLO

Cómo componer una librería con los elementos enumerados en las siguientes páginas

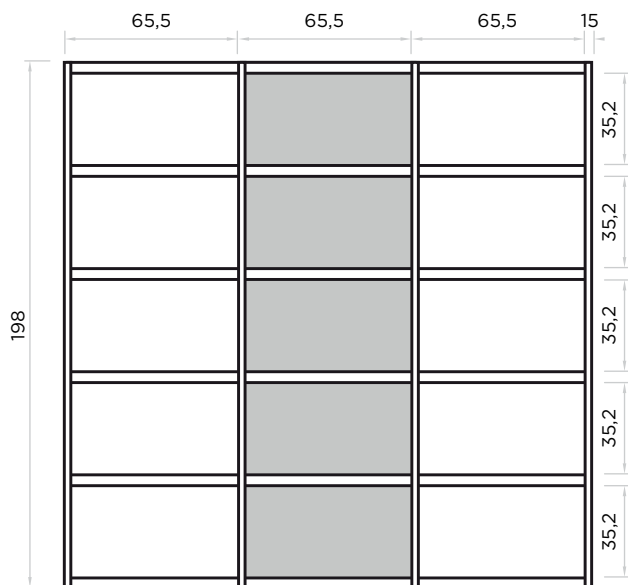

La libreria sopra rappresentata è composta dai seguenti elementi:

The library above is composed by the following elements:

La bibliothèque dessus est fait des éléments suivants:

Die bucherwand oben besteht aus folgenden elementen:

La librería encima ha los siguientes elementos:

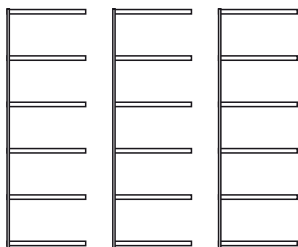

+



+



montante + vano 64 cm
upright + 64 cm compartment
montant + compartiment 64 cm
Pfosten + fach 64 cm
montante + compartimiento 64 cm

schienale
back panel
panneau de fond
Rückwand
respaldo

montante finale
final upright
montant final
Endpfosten
montante final





65,5 x 32 x 198H
25.8" x 12.6" x 78"H

64 x 198H
25.2" x 78"

cm 1,5 x 32 x 198H
0.5" x 12.6" x 78"H

RIPIANI SHELVES ÉTAGÈRES BOEDEN ESTANTES	→	bianco (B) oppure laccato colore (vedi codici e prezzi nella tabella in fondo a pag. 81) white (B) or lacquered colour (see codes and prices in the table at the bottom of page 81) blanc (B) ou couleurs laquées (consultez les codes et les prix dans le tableau au bas de la page 81) Weiß (B) oder farblich lackiert (siehe Code und Preise in der Tabelle am Ende der Seite 81) blanco (B) o laqueado en color (ver códigos y precios en la tabla de la parte inferior de la pág. 81)		
MONTANTI UPRIGHTS MONTANTS PFOSTEN MONTANTES	→	faggio imbiancato whitened beech hêtre blanchi Buche weiss haya blanqueada	faggio tinto moca mocha beech hêtre moka Buche Mokka haya moca	faggio naturale natural beech hêtre blanchi Buche natur haya natural

				
1,5 + 16 cm 0.5" + 6.3"	cm 17,5 x 32 x 198H 6.8" x 12.6" x 78"H	SP6161...B	SP6163...B	SP6162...B
				
1,5 + 32 cm 0.5" + 12.6"	cm 33,5 x 32 x 198H 13.1" x 12.6" x 78"H	SP6321...B	SP6323...B	SP6322...B
				
1,5 + 64 cm 0.5" + 25.2"	cm 65,5 x 32 x 198H 25.8" x 12.6" x 78"H	SP6641...B	SP6643...B	SP6642...B
				
1,5 + 80 cm 0.5" + 31.5"	cm 81,5 x 32 x 198H 32.1" x 12.6" x 78"H	SP6801...B	SP6803...B	SP6802...B
				
1,5 + 96 cm 0.5" + 37.8"	cm 97,5 x 32 x 198H 38.4" x 12.6" x 78"H	SP6961...B	SP6963...B	SP6962...B

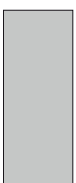
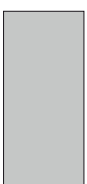
SCHIENALI BACK PANEL FONDS RÜCKWÄNDE RESPALDOS →	bianco white blanc Weiss blanco B	nero black noir Schwarz negro Z	argento silver argent Silber plata A	giallo yellow jaune Gelb amarillo G	grafite graphite graphite Graphit grafito H	grigio gray gris Grau gris E	moca mocha moka Mokka moca W	rosso red rouge Rot rojo R	verde green vert Grün verde D	oro gold or Gold de oro J
 cm 64 x 38H 25.2" x 14.9"H	SS064B	SS064Z	SS064A	SS064G	SS064H	SS064E	SS064W	SS064R	SS064D	SS064J
 cm 96 x 38H 37.8" x 14.9"H	SS096B	SS096Z	SS096A	SS096G	SS096H	SS096E	SS096W	SS096R	SS096D	SS096J
 cm 16 x 198H 6.3" x 78"H	SSV16B	SSV16Z	SSV16A	SSV16G	SSV16H	SSV16E	SSV16W	SSV16R	SSV16D	SSV16J
 cm 32 x 198H 12.6" x 78"H	SSV32B	SSV32Z	SSV32A	SSV32G	SSV32H	SSV32E	SSV32W	SSV32R	SSV32D	SSV32J
 cm 64 x 198H 25.2" x 78"H	SSV64B	SSV64Z	SSV64A	SSV64G	SSV64H	SSV64E	SSV64W	SSV64R	SSV64D	SSV64J
 cm 80 x 198H 31.5" x 78"H	SSV80B	SSV80Z	SSV80A	SSV80G	SSV80H	SSV80E	SSV80W	SSV80R	SSV80D	SSV80J
 cm 96 x 198H 37.8" x 78"H	SSV96B	SSV96Z	SSV96A	SSV96G	SSV96H	SSV96E	SSV96W	SSV96R	SSV96D	SSV96J

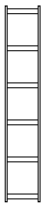
MONTANTE FINALE FINAL UPRIGHT MONTANT FINAL ENDPFOSTEN MONTANTE FINAL	faggio imbiancato whitened beech hêtre blanchi Buche weiss haya blanqueada	faggio tinto moca mocha beech hêtre moka Buche Mokka haya moca	faggio naturale natural beech hêtre blanchi Buche natur haya natural
 cm 32 x 1,5 x 198H 12.6" x 0.5" x 78"H	SWN191	SWN193	SWN192

**ALCUNI ESEMPI DI
COMPOSIZIONI**

**A FEW EXAMPLES OF
COMPOSITIONS**

**QUELQUES EXEMPLES DE
COMPOSITIONS**

**EINIGE BEISPIELE VON
KOMPOSITIONEN**

**ALGUNOS EJEMPLOS DE
LIBRERÍAS COMPOSICIONES**

<p>RIPIANI E SCHIENALI SHELVES AND BACK PANELS ÉTAGÈRES ET FONDS BOEDEN UND RÜCKWÄNDE ESTANTES Y RESPALDOS</p> <p>→</p>	<p>bianco (B) oppure laccato colore (vedi codici e prezzi nella tabella in fondo alla pagina) white (B) or lacquered colour (see codes and prices in the table at the bottom of the page) blanc (B) ou couleurs laquées (consultez les codes et les prix dans le tableau au bas de la page) Weiß (B) oder farblich lackiert (siehe Code und Preise in der Tabelle am Ende der Seite) blanco (B) o laqueado en color (ver códigos y precios en la tabla de la parte inferior de la página)</p>		
<p>MONTANTI UPRIGHTS MONTANTS PFOSTEN MONTANTES</p> <p>→</p>	<p>faggio imbiancato whitened beech hêtre blanchi Buche weiss haya blanqueada</p>	<p>faggio tinto moca mocha beech hêtre moka Buche Mokka haya moca</p>	<p>faggio naturale natural beech hêtre blanchi Buche natur haya natural</p>

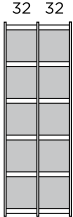
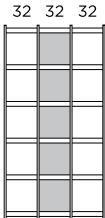
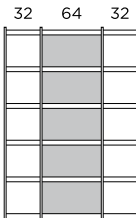
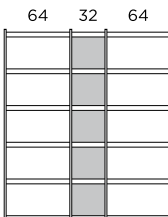
 <p>32 32</p> <p>cm 68,5 x 32 x 198H 26.9" x 12.6" x 78"H</p>	SW753...B	SD753...B	SN753...B
 <p>32 32 32</p> <p>cm 102 x 32 x 198H 40.1" x 12.6" x 78"H</p>	SW074...B	SD074...B	SN074...B
 <p>32 64 32</p> <p>cm 134 x 32 x 198H 52.7" x 12.6" x 78"H</p>	SW324...B	SD324...B	SN324...B
 <p>64 32 64</p> <p>cm 166 x 32 x 198H 65.4" x 12.6" x 78"H</p>	SW364...B	SD364...B	SN364...B

PREZZO PRICE PRIX PREIS PRECIO	nero black noir Schwarz negro	argento silver argent Silber plata	giallo yellow jaune Gelb amarillo	grafite graphite graphite Graphit grafito	grigio gray gris Grau gris	moca mocha moka Mokka moca	rosso red rouge Rot rojo	verde green vert Grün verde	oro gold or Gold de oro
	Z	A	G	H	E	W	R	D	J
	+10%	+15%	+10%	+10%	+10%	+10%	+10%	+10%	+15%

**ALCUNI ESEMPI DI
COMPOSIZIONI**

**A FEW EXAMPLES OF
COMPOSITIONS**

**QUELQUES EXEMPLES DE
COMPOSITIONS**

**EINIGE BEISPIELE VON
KOMPOSITIONEN**

**ALGUNOS EJEMPLOS DE
LIBRERÍAS COMPOSICIONES**

<p>RIPIANI E SCHIENALI SHELVES AND BACKS ÉTAGÈRES ET FONDS BOEDEN UND RÜCKWÄNDE ESTANTES Y RESPALDOS</p> <p>→</p>	<p>bianco (B) oppure laccato colore (vedi codici e prezzi nella tabella in fondo alla pagina) white (B) or lacquered colour (see codes and prices in the table at the bottom of the page) blanc (B) ou couleurs laquées (consultez les codes et les prix dans le tableau au bas de la page) Weiß (B) oder farblich lackiert (siehe Code und Preise in der Tabelle am Ende der Seite) blanco (B) o laqueado en color (ver códigos y precios en la tabla de la parte inferior de la página)</p>			
<p>MONTANTI UPRIGHTS MONTANTS PFOSTEN MONTANTES</p> <p>→</p>	<p>faggio imbiancato whitened beech hêtre blanchi Buche weiss haya blanqueada</p>	<p>faggio tinto moca mocha beech hêtre moka Buche Mokka haya moca</p>	<p>faggio naturale natural beech hêtre blanchi Buche natur haya natural</p>	

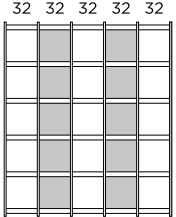
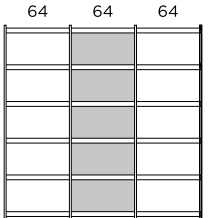
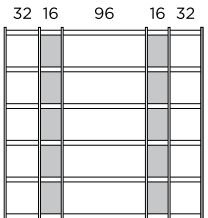
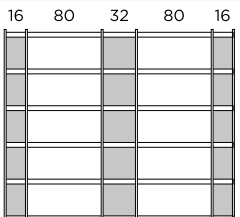
 <p>cm 169 x 32 x 198H 66.5" x 12.6" x 78"H</p>	SW366...B	SD366...B	SN366...B
 <p>cm 198 x 32 x 198H 78" x 12.6" x 78"H</p>	SW394...B	SD394...B	SN394...B
 <p>cm 201 x 32 x 198H 79.1" x 12.6" x 78"H</p>	SW411...B	SD411...B	SN411...B
 <p>cm 233 x 32 x 198H 91.8" x 12.6" x 78"H</p>	SW432...B	SD432...B	SN432...B

PREZZO PRICE PRIX PREIS PRECIO	nero black noir Schwarz negro	argento silver argent Silber plata	giallo yellow jaune Gelb amarillo	grafite graphite graphite Graphit grafito	grigio gray gris Grau gris	moca mocha moka Mokka moca	rosso red rouge Rot rojo	verde green vert Grün verde	oro gold or Gold de oro
	Z	A	G	H	E	W	R	D	J
	+10%	+15%	+10%	+10%	+10%	+10%	+10%	+10%	+15%

**ALCUNI ESEMPI DI
COMPOSIZIONI**

**A FEW EXAMPLES OF
COMPOSITIONS**

**QUELQUES EXEMPLES DE
COMPOSITIONS**

**EINIGE BEISPIELE VON
KOMPOSITIONEN**

**ALGUNOS EJEMPLOS DE
LIBRERÍAS COMPOSICIONES**

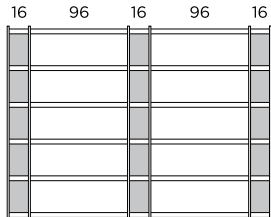
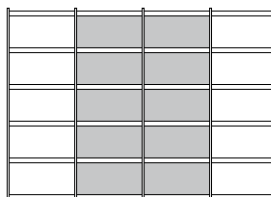
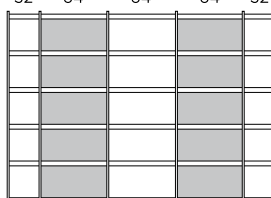
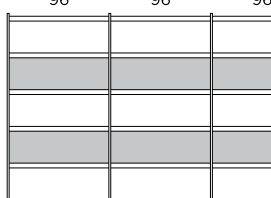
<p>RIPIANI E SCHIENALI SHELVES AND BACKS ÉTAGÈRES ET FONDS BOEDEN UND RÜCKWÄNDE ESTANTES Y RESPALDOS</p> <p>→</p>	<p>bianco (B) oppure laccato colore (vedi codici e prezzi nella tabella in fondo alla pagina) white (B) or lacquered colour (see codes and prices in the table at the bottom of the page) blanc (B) ou couleurs laquées (consultez les codes et les prix dans le tableau au bas de la page) Weiß (B) oder farblich lackiert (siehe Code und Preise in der Tabelle am Ende der Seite) blanco (B) o laqueado en color (ver códigos y precios en la tabla de la parte inferior de la página)</p>			
<p>MONTANTI UPRIGHTS MONTANTS PFOSTEN MONTANTES</p> <p>→</p>	<p>faggio imbiancato whitened beech hêtre blanchi Buche weiss haya blanqueada</p>	<p>faggio tinto moca mocha beech hêtre moka Buche Mokka haya moca</p>	<p>faggio naturale natural beech hêtre blanchi Buche natur haya natural</p>	
 <p>cm 249 x 32 x 198H 98.1" x 12.6" x 78"H</p>	SW443...B	SD443...B	SN443...B	
 <p>cm 263,5 x 32 x 198H 103.8" x 12.6" x 78"H</p>	SW455...B	SD455...B	SN455...B	
 <p>cm 265 x 32 x 198H 104.4" x 12.6" x 78"H</p>	SW456...B	SD456...B	SN456...B	
 <p>cm 294 x 32 x 198H 115.8" x 12.6" x 78"H</p>	SW494...B	SD494...B	SN494...B	

<p>PREZZO PRICE PRIX PREIS PRECIO</p>	<p>nero black noir Schwarz negro</p> <p>Z +10%</p>	<p>argento silver argent Silber plata</p> <p>A +15%</p>	<p>giallo yellow jaune Gelb amarillo</p> <p>G +10%</p>	<p>grafite graphite graphite Graphit grafito</p> <p>H +10%</p>	<p>grigio gray gris Grau gris</p> <p>E +10%</p>	<p>moca mocha moka Mokka moca</p> <p>W +10%</p>	<p>rosso red rouge Rot rojo</p> <p>R +10%</p>	<p>verde green vert Grün verde</p> <p>D +10%</p>	<p>oro gold or Gold de oro</p> <p>J +15%</p>
--	---	--	---	---	--	--	--	---	---